



Quick mold change solutions



EAS Quick Mold Change (QMC) System Reduces Manufacturing Cost

Quick Mold Changes Systems lower manufacturing cost by reducing change over time. Frequent mold changes allow inventory to be reduced and provide faster response to customer requirements.

EAS provides the following QMC solutions:

- Clamping
- Multi-Couplers
- Ejector Couplers
- Mold Handling
- Pre-heating

With These Solutions You Can Achieve:

- Increased Machine Productivity
- Reduced Labour Cost
- Inventory Reduction
- Increased Flexibility
- Faster Response
- Improved Safety

Resulting in lower manufacturing cost for you...

Step-by-step Automation

QMC Solutions can be applied in a series of cost effective steps. First you will need to analyze the complete mold change process step by step to identify where down time losses are occurring. Molds that are used most frequently are your best candidates and provide the best return on investment. These molds should be dedicated to a specific machine or group of machines.

This analysis will identify where you should start applying QMC solutions.

In most cases, clamping will be the first step to reducing mold change time. Quick clamping systems are not only faster, but also safer, as tool set up people no longer need to climb into the machine or under the mold to clamp up.

Ask *EAS* changesystems...

- **For the best solution for your application.**
- **For a Return on Investment calculation.**
- **For the complete SMED solutions from one global source.**

EAS OFFERS YOU THE MOST COMPLETE RANGE OF CLAMPING SOLUTIONS

Content:

Chapter:

Clamping systems and ejector systems

1.1 - 1.10



1

Manual and automatic multi couplers

2.1 - 2.2



2

Mold change tables and cars

3.1 - 3.10



3

Service units and storage systems

4.1 - 4.3



4



1.1
Adaptive manually operated
clamping systems
p. 6-7



1.6
Adaptive single acting
hydraulic mold clamping
p. 16-17



1.2
Adaptive hydraulic mold
clamping systems
p. 8-9



1.7
Electro permanent magnetic
clamping
p. 18-21



1.3
Mold change options (vertical)
p. 10-11



1.8
Ejector couplers
p. 22-23



1.4
Mold change options
(horizontal)
p. 12-13



1.8
Retrofit packages
p. 24-25



1.5
Integrated hydraulic mold
clamping systems EAS Engel
p. 14-15



1.10
Vertical presses and QMC
p. 26-27

1

Clamping systems and ejector systems

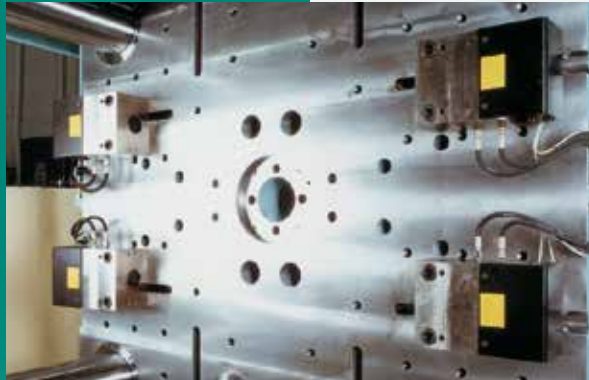

Adaptive, manually operated clamping systems

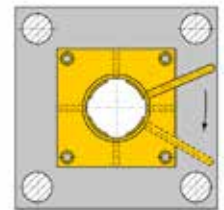
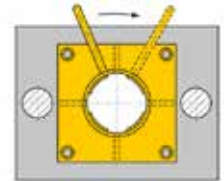
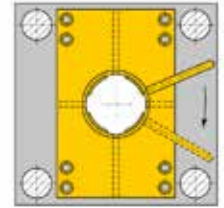

Application examples

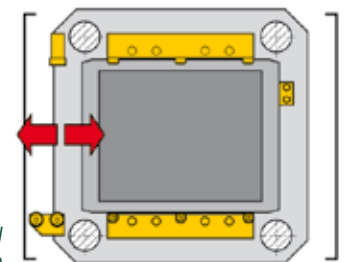
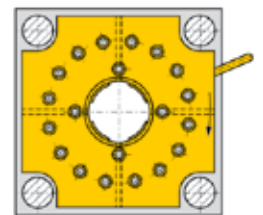

Horizontal mold change

A SIMPLE ADAPTIVE MANUAL CLAMPING SOLUTION



*Mold side:
Molds can be easily fitted with
bayonet centering adapters*

A simple adaptive clamping solution for new or existing injection molding machines and other applications.

The manual bayonet clamping systems consists of a clamping adapter plate that is bolted to each platen using existing Euromap threaded holes. On the stationary side of the mold the existing locating ring is replaced by one of our bayonet centering adapters. The moveable side of the mold will also require a bayonet centering adapter. When loading the mold into the machine the stationary side bayonet adapter is pushed into the stationary clamping plate. The mold is located on the machine platen-locating ring. The mold is locked in place by a simple 53 degrees rotation of the lever. The machine is closed and the process is repeated on the moving side.

The systems are suitable for molds that weight up to 2 t and injection molding or rubber molding machines up to 250 t capacity.

The clamping adapter plates are 17 or 22 mm thick with centering ring sizes of 100, 110, 125 and 160 mm. The manual system does not require mold standardization other then mounting of the bayonet adapter rings. Bayonet adapter rings are also available for tools with insulating platens.



*Machine side:
A clamping
adapter plate
is mounted on
each platen.
The clamping
adapter plate
is drilled to
fit Euromap
mounting
plattens*

EAS Manual Clamping Solutions for SPI Platen Standards

Manual clamping solutions are available for SPI machines with multiple ejector bar holes. These systems utilize a rack and pinion to rotate the lock ring to clamp the mold in place. The SPI manual clamp systems are equipped with removable handles. SPI clamping plates have a thickness of 1" inch. Bayonet adapter rings are available in a variety of configurations.

■ EAS can also supply simple roller systems with manual clamping for horizontally loading molds.

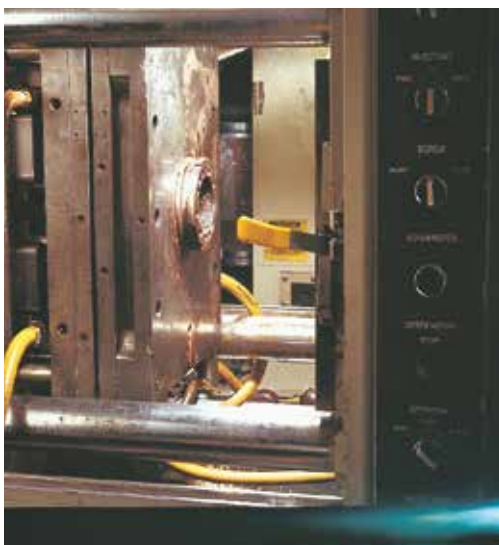

*A clamping
adapter plate
is mounted
to each SPI
platen*



Adaptive hydraulic mold clamping systems

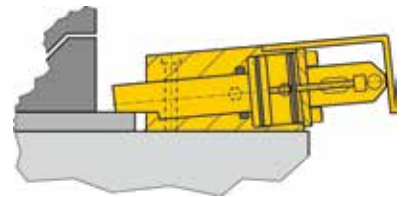

All these cylinders can be ordered for several backplate heights and mounting screws sizes.

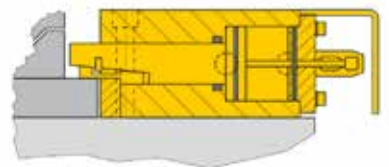

THE IDEAL SOLUTION FOR AUTOMATED QMC SYSTEMS

1.2



Hydraulic clamping is the ideal solution for more automated QMC requirements. Suitable for new or existing injection molding machines from 50 to 10,000 tonnes capacity.

A typical quick clamping system consists of 4 or more double acting hydraulic clamps, which are mounted to both platens. The clamp plungers are angled at a 5 degrees to provide a self-locking feature. Pressure does not have to be maintained for the clamps to remain locked providing additional safety during the molding operation.

EAS offers two series of self-locking wedge clamps: MOD/WOD series with the 5 degrees plungers and the WS series, which uses an internal, wedging feature. Both series clamp on flat back plates and can be equipped with 2 proximity switches to indicate the clamped and unclamped positions.

The MOD series is the metric version for use on Euromap standard machines and feature metric mounting patterns and BSP oil connections.

The WOD series is the imperial version for use on American SPI standard machines and feature imperial mounting patterns and SAE oil connections.

The back plates of the molds that are used with these series of clamps must be standardized because the clamps will be fixed to the platen. Clamps selection is determined by dividing the opening force of the machine by the number of clamps. Example: A machine with an opening force of 800kN (80 t) would need 4 clamps per platen, each with a 200kN (20 t) capacity or the MOD/WOD 2010.

Clamps are available in the following capacities: 15, 30, 60, 110, 200, 400, 600 & 1200kN.

Standard temperature range: 60° C (140° F)

High temperature seals and proximity switches available on request.

MOD/WOD/NOD SERIES

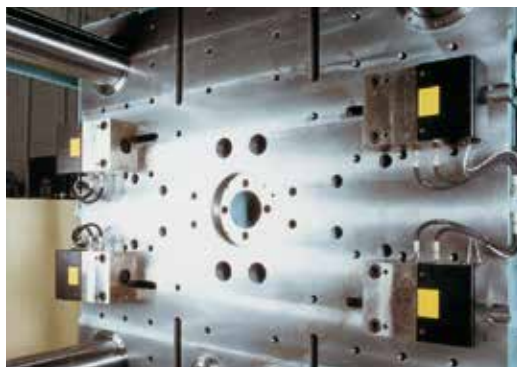

The WS series clamps utilize an internal wedge system, which allows a greater tolerance on the back plate thickness.

Clamps can be equipped with 2 proximity switches to indicate the clamped and unclamped positions. This series of clamp also requires standardized mold back plates.

Clamps are available in the following capacities: 80, 200 & 350 kN.

WS-SERIES

Mold change options

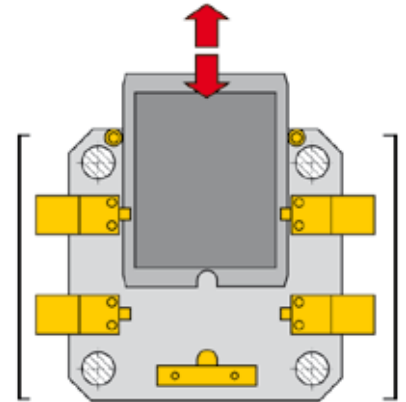
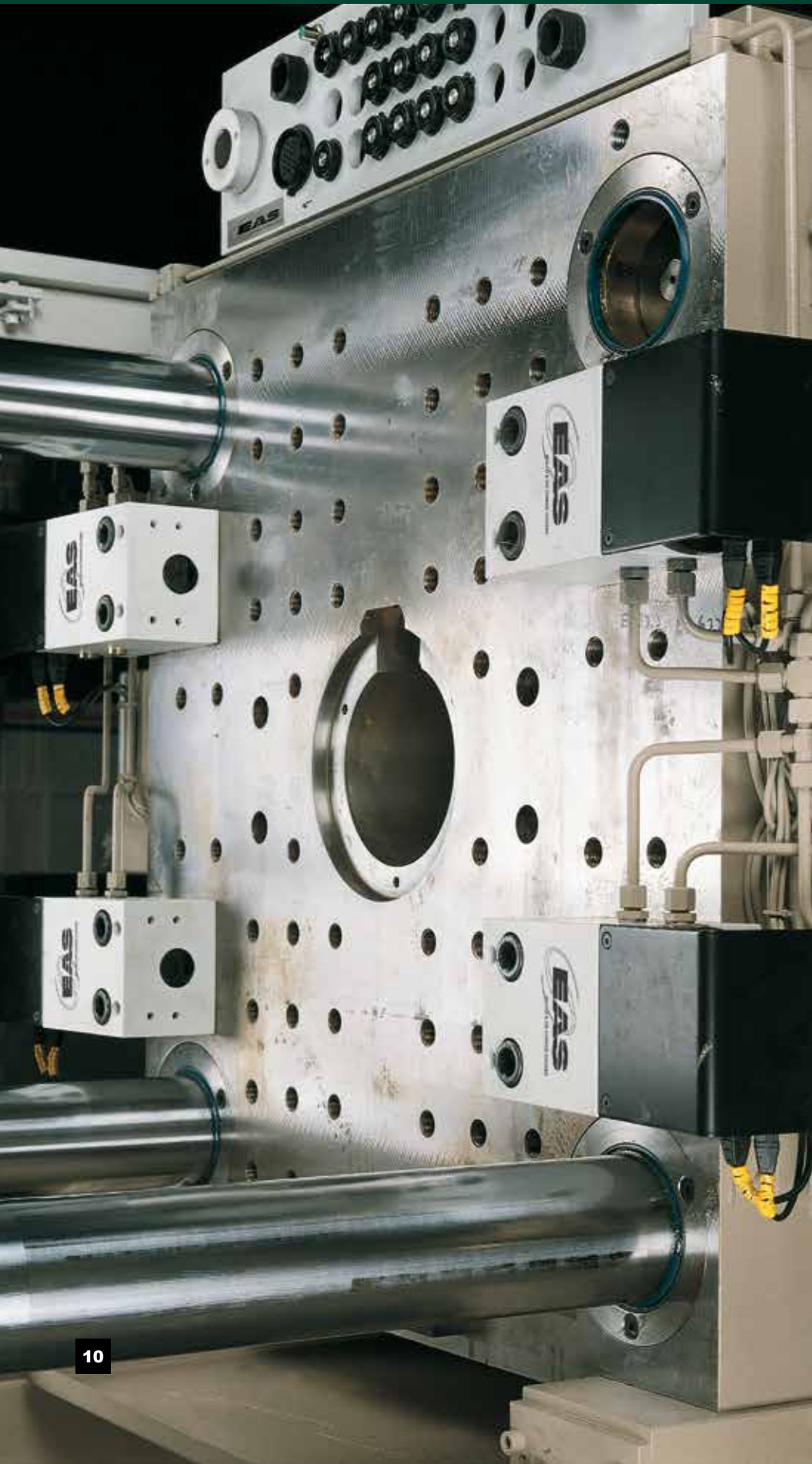

Vertical load mold change solution with fixed clamps

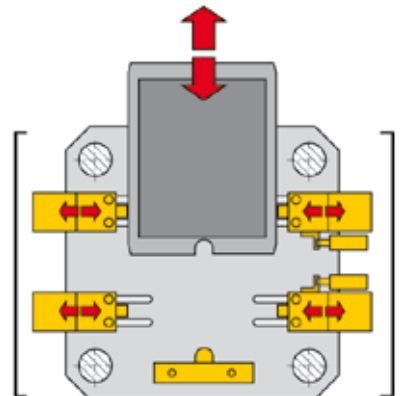

Vertical load mould change solution with, movable clamps. Clamps are moved manually or with hydraulic cylinders.

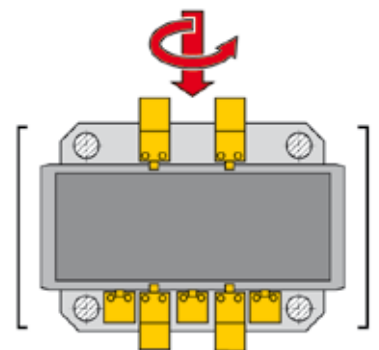

Vertical load and rotate fixed clamp solution

VERTICAL LOAD MOLD CHANGE

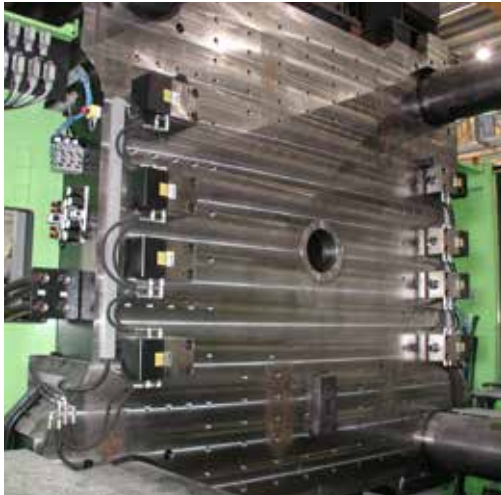

Clamping on the fixed side



Manual movable clamps

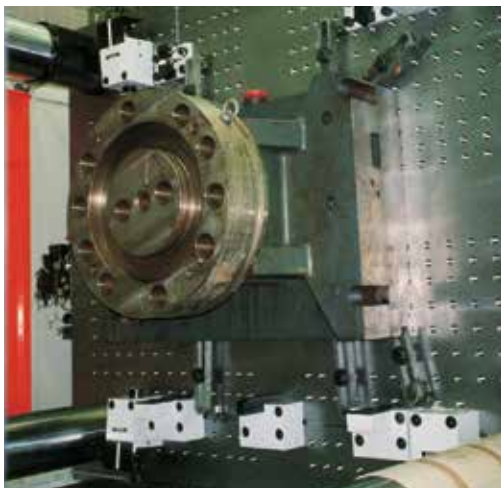

Drop and rotate solution with safety latches (the mold on this machine is just for testing)

Slide plates and mold guides on a cylinder



Vertical load mold change is the most common method of loading molds into the machine.

For this method the hydraulic clamps are positioned vertically between the tie bars on both platens.

On the fixed platen 4 clamps would be mounted with guides, slide plates, tie bar protectors and mold stop locator. The mold slides in behind the mold guides and is positioned by the mold stop locator. The clamps can then be activated and the mold is clamped on the fixed platen. The movable platen is then closed and the movable platen clamps are then activated. The mold is now securely clamped.

Centering rings are not required when using standardized back plates.

■ Movable clamps

Movable clamps can be used when fully standardized back plates are not feasible.

MOD/WOD series clamps can be made movable in T-slots. This movement can be accomplished manually or automatically using a pneumatic or hydraulic cylinder. When done automatically the clamp sensor will determine if the clamp has reached the back plate. The cylinders are mounted on long T-nuts for accurate movement in the T-slots. It will still be necessary to standardize the back plate thickness at the clamping points as well as the height from the base to centerline if a mold stop locator is used.

■ Vertical Load & Rotate

Large molds are often wider than the tie bar gap but must be rotated between the tie bars when loaded vertically. For this requirement the MOD/WOD clamps are positioned horizontally between the tie bars. Support ledges with a centering device position and center the mold accurately.

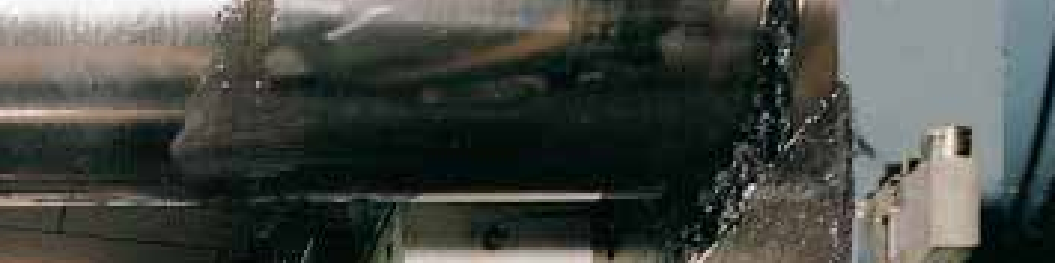

Mold change options

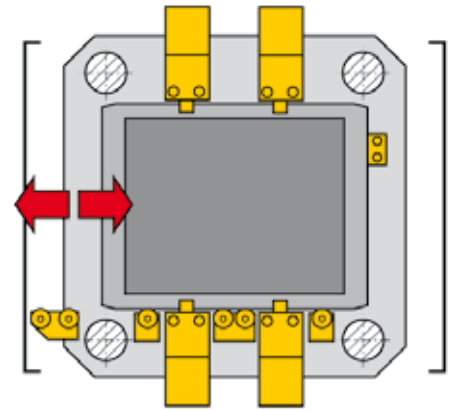
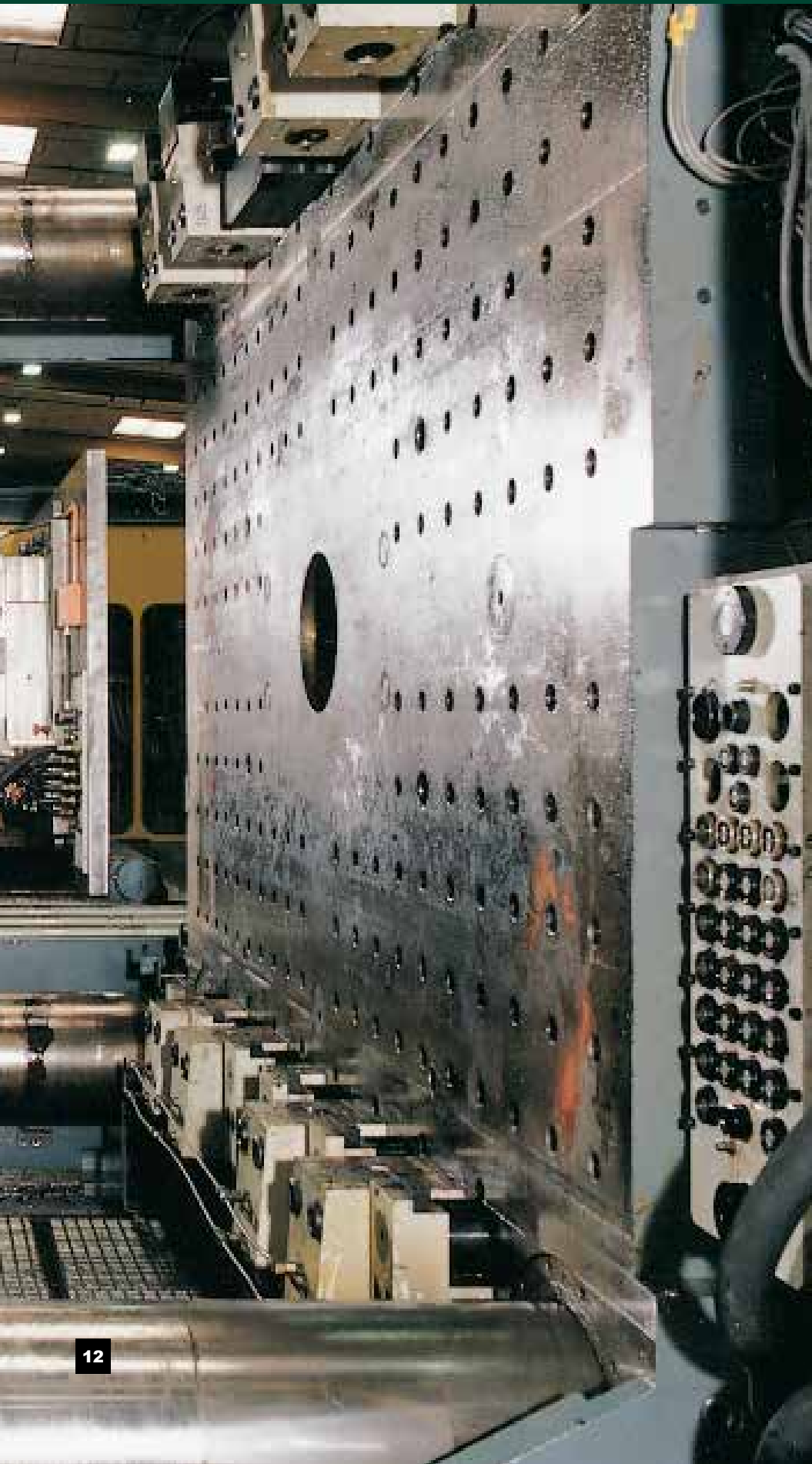

*Horizontal load mold change
with non powered rollers*

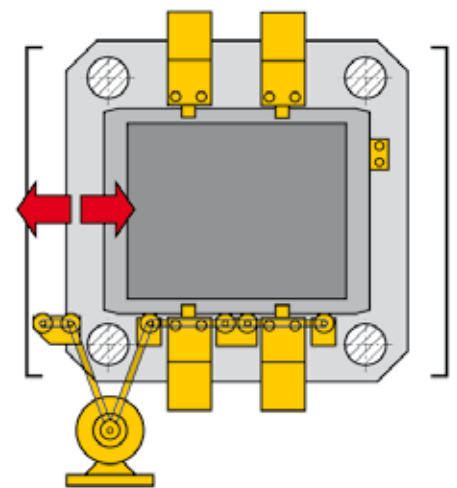

*Horizontal load mold change with
powered roller transfer*

HORIZONTAL MOLD CHANGE UTILIZING A MOLD CHANGE CAR OR TABLE



Powered roller system on a 500 t machine

When molds are to be changed horizontally, clamps are positioned horizontally between the tie bars. The platens are equipped with rollers that allow the mold to roll into the press from a mold changing cart or table.

Pre-rollers are used to support the mold between the safety gate and the edge of the platen. Mold stops accurately position standardized molds in the machine. Centering cylinders position the mold when back plate length is not standardized. All systems include mold guides on the stationary platen and safety bars on the moveable platen. This prevents the mold from falling if the clamps are inadvertently retracted. These solutions require standardized mold back plates



Horizontal loading of a 40 t mold from a change table into a 3200 t machine. The system included pre-rollers, centering cylinders, MOD 4010 clamps and multicouplers

■ Horizontal loading with powered rollers. A powered roller system is an alternative method for transferring the mold from the change cart or table into the machine. It replaces a telescopic push/pull device.

The mold change cart or table and the stationary platen are equipped with powered rollers while the moveable platen has non-powered rollers. The powered rollers allow the mold to be changed more quickly than telescopic push/pull devices. They also allow easy change for machines that are on either side of the cart or table.



Integrated hydraulic mold clamping systems EAS Engel

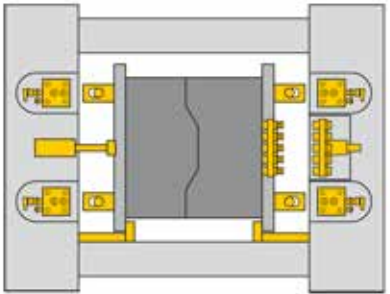
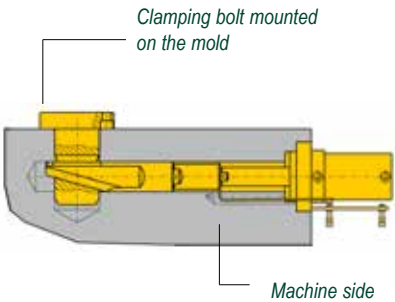

Horizontal loading solution with integrated clamping system

MOUNTING IN THE MACHINE PLATEN, LEAVES THE PLATEN COMPLETELY FREE

The hydraulic cylinder with the wedge and the clamping bolt



The integrated hydraulic clamping system (Engel System) is mounted to the sides of the platen, leaving the platen face completely free of obstructions. Depending on machine size the mold is clamped using 2, 4 or 8 clamps per platen.

Each mold would have the corresponding number of EEB clamping bolts mounted to each side of the mold. Clamping is achieved when the hydraulic cylinder moves the wedge on the end of the plunger into the matching wedge shaped slot in the clamping bolt. On small injection molding machines only 2 hydraulic cylinders per platen are required for clamping. On larger machines (up to 2500 t), 4 hydraulic clamping cylinders per platen are required to handle the forces defined by Euromap 11 and VDMA specifications. On very large machine 8 hydraulic cylinders are required to insure trouble free clamping. Location of the clamping cylinders and clamping bolts must be standardized, and utilizes the centering ring for final mold location. The integrated hydraulic system can be applied to any new machine where the platens can be easily modified to accept the system. These platen modifications do not make it applicable for retrofit to existing machines.

The integrated system keep the platens free



No standardization of the mold or back plates is required except for mounting of the clamping bolts. The full platen area can be used for larger molds. For horizontal load mold change the mold is moved in over rollers and uses a mold stop for final position. For horizontal loading the mold must be standardized for the bottom to the centerline for proper alignment. The closing movement of the machine will push the clamping bolts into the platens. This movement can also be used connect the multi-coupler systems. To pull the clamping bolts out of the platens, the opening of the machine can be used or additional push cylinders can be mounted to the machine.

Hydraulic integrated clamping systems with 2 proximity switches for clamp position feedback.



EEB mold mounted bolts.

Adaptive single acting hydraulic mold clamping systems



Single acting ELY cylinders can be powered by the EAS air hydraulic pump units with on each plate 2 circuits for safety purposes.

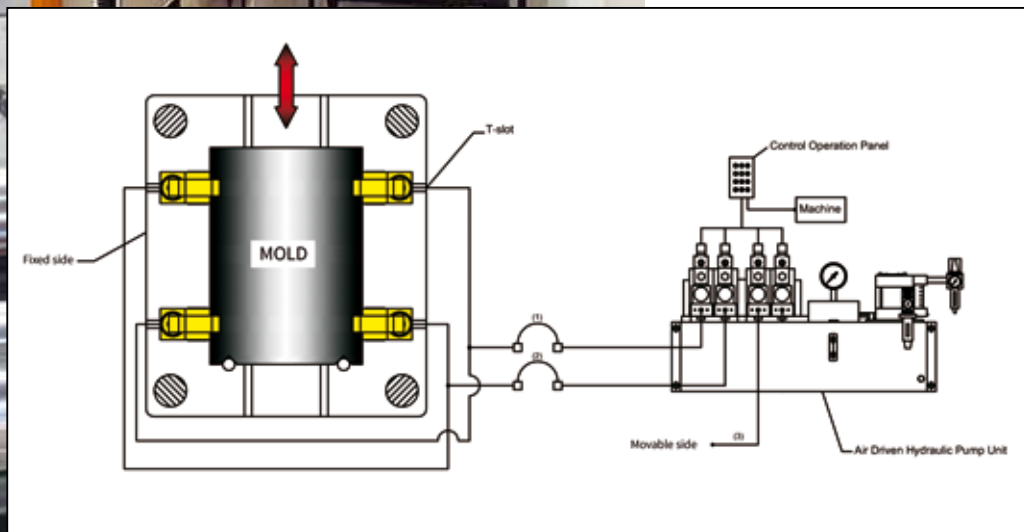

THE IDEAL SOLUTIONS FOR MACHINES EQUIPPED WITH T SLOTS

1.6



A typical quick clamping system consists of 4 or more single acting hydraulic clamps which are mounted to both platens.

Pressure must be maintained on the clamps and this is in most application achieved by using the EASchangesystem Air Hydraulic pump unit.

The ELY series are equipped with a T-stove.

Also available with air movable cylinder, proximity switch and pilot operated check valve for automatic clamp movements towards the mold instead of manual sliding of the clamps. The ELY clamps are available in the following capacities: 20, 40, 60, 100, 160 and 250 kN at 350 bar pressure (175 bar series on request).

Standard temperature range is 0-200°C which make these clamps also suitable for higher temperatures such as on die casting machines.

For retrofit applications these clamps can be ideally operated by the EASchangesystems Air Hydraulic pump units.



Air hydraulic pump unit, EASy to install, EASy to operate.

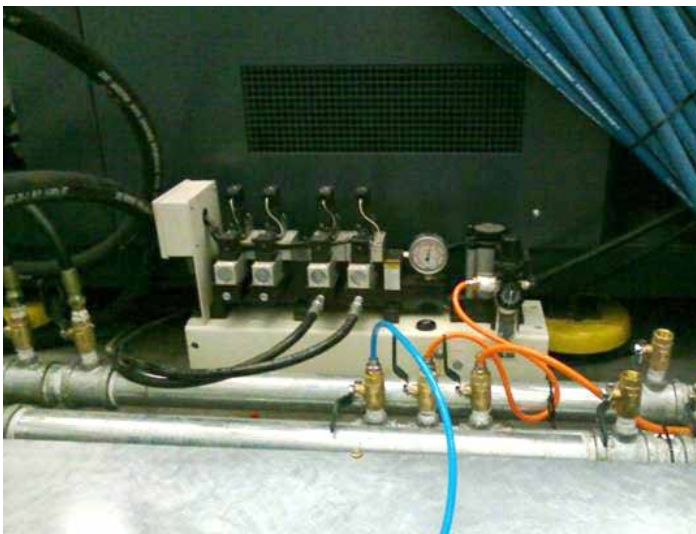

Electropermanent magnetic clamping



Pressmag SP

- Very suitable for smaller sizes of injection molding machines (<800T).
- Small square/round poles, resulting in high forces within limited areas and despite holes. Standard 45 x 45 mm poles with stainless steel mesh seal, for cleaner and longer life.
- Up to 150 °C (300°F)
- Plate thickness 38 mm.(1.5")
- 2,45 kN force per pole

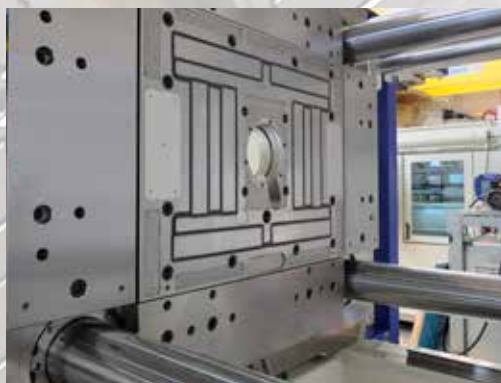

Pressmag HP

- Very suitable for larger sizes of injection molding machines. (>800T)
- High flux generation, high forces on smaller molds
- Standard 310 mm(12.2") long poles with resin sealing
- Up to 100° C.(212°F)
- Plate thickness 55 mm(2.16").
- Non magnetic filling plates outside the tie bar area with flux concentrating
- 25 kN force per pole



Pressmag LP

- Suitable for midsize and large machines
- Standard exchangeable long poles
- Available with innovative touch screen control unit
- Metal to metal sealing
- Force and temperature measurement
- Operational touch screen panel with different languages selection
- Up to 100 °C (212 °F)
- Plate thickness 55 mm (2.16 ")

EAS PRESSMAG SP. THE BEST SOLUTION FOR SMALL SIZE MACHINES UP TO 4000 KN (400 T)

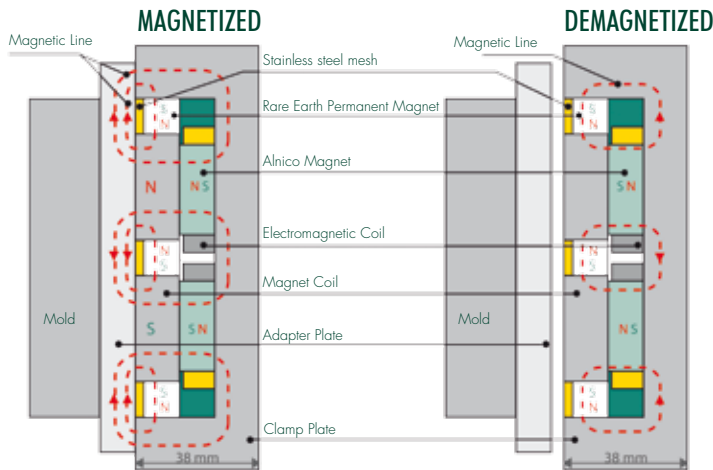

Square pole technology

To ensure highest clamping forces at all times, Pressmag SP systems have small poles. This also enables maximum versatility around ejector and mounting holes.

Smaller square poles for smaller machines:

- Have higher overall clamping force
- Maximize daylight opening between the platens
- Are easier to position around ejector holes

By using the maximum number of mounting points available, EASchangesystems ensures the secure mounting of the Pressmag SP system.



Pressmag SP on a 4000 kN (400 t) machine

Pressmag SP

Electropermanent magnetic Pressmag SP systems have a 47 mm (1.85") square base and feature a pole to pole design - alternating north - south poles. This provides more clamping force towards the center of the platens on small machines and thinner 38mm Pressmag plate for minimum loss of daylight.

Pressmag SP100 is designed for a max temperature of 100 °C (212 °F) and features square poles with resin sealing. Pressmag SP150 has laser-cut stainless steel mesh seals and covers the complete system, providing an easy-to-clean, perfectly flat all steel surface. The Pressmag SP 150 is designed for high temperature applications up to 150 °C (302 °F).

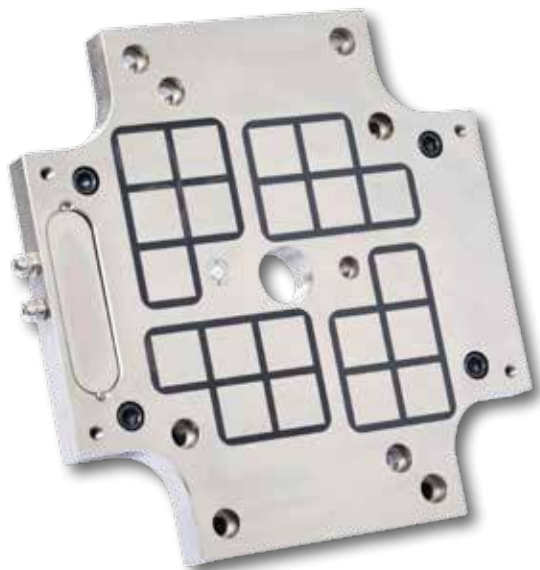

EAS-y-MAG: EAS-y-MAG 75 for a 750 kN (75 t) machine

EAS-y-MAG

EAS-y-MAG systems consist of two standard plates with square poles and resin sealing for a maximum temperature of 100°C (212°F). These standard plates are available for machine sizes of 500, 750, 1000, 1500 and 2000 kN (50, 75, 100, 150 and 200 tons). Available with the E 70.0 standard control interface or with a simple control - IL 1 interface.

PRESSMAG HP AND PRESSMAG LP. THE OPTIMUM SOLUTION FOR MIDSIZE AND LARGE MACHINES UP TO 45000 KN (4500 T)

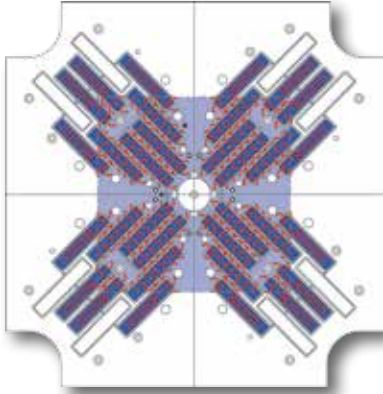

Long pole technology

The EASchangesystems long pole technology is used on larger machines because the magnetic flux (the holding force) is always concentrated on the mold. Even when the pole is only partially covered.

Longer poles for bigger machines:

- Have higher holding forces
- Minimizes stray flux
- Minimize the air gap

The frame of the Pressmag LP system is very stiff, preventing bending of the plate, thus minimizing an air gap resulting in no loss of holding forces and machine shut down.



Pressmag HP on a 32000 kN (3200 t) machine

Pressmag HP

For machines bigger than 4000 kN (400 t), the Pressmag HP offers long pole technology. This ensures highest magnetic flux concentration and superior clamping forces, with only 55 mm (2.16") plate thickness.

Like the Pressmag LP system, the electropermanent Pressmag HP is a compensated system. When activated, the long pole becomes the north pole and the frame plate becomes the south pole. Clamping the mold in place, the Neodymium rare-earth and AlNiCo magnets stay active until deactivation, and the clamping force remains absolutely constant. Even in case of power outage!



Pressmag LP on a 9000 kN (900 t) machine

Pressmag LP

The latest generation Pressmag LP system is ideally suitable for use on large, 4000-45000 kN (400-4500 t) capacity injection molding machines operating in 100 °C (212° F) mold temperature environments. The long pole shape of the Pressmag LP is oval, as opposed to the rectangular pole shape of the Pressmag HP. These pre-assembled plug in oval pole design facilitates the easy exchange of poles. Furthermore this system offers a plate thickness of 55 mm (2.16") with touch screen controls and metal-to-metal clamping surface. This feature enables exact force measurement.

Pressmag LP advantages:

- New state of the art MAGTCU 13 controls with touch-screen display for accurate and reliable system monitoring
- Multiple levels of access for total operating staff security, APAVE tested.
- The only electropermanent magnetic clamping system that meets latest ISO standards for injection molding machines
- System clamping force remains absolutely constant in case of power outage
- System automatically adapts to varying electrical power conditions (amperage, voltage and frequency)
- Automatic diagnostic function of control unit's internal components/sensors for easy troubleshooting
- Quick and Easy to install - instant availability
- Can be used on new and existing injection molding machines
- Simple and safe to operate



Certification

EAS changes systems controls are designed and built especially for Pressmag solutions. They ensure safe and trouble-free operation of your injection molding or die change operation. The Pressmag control units meet the latest ISO, VMA and SPI standards.

The interface between injection molding machine and our Pressmag systems is defined as follows:

- E 70.0 when existing molding machines are retrofitted
- E 70.1 for new machines with controls already integrated into the machine controls
- E 72 recommendation for integration in machine controls

Simplified Control Unit IL1

- Used on Pressmag SP
- When machine interface do not conform Euromap E 70
- Includes simple e-stop safety



IL1
Control Unit

Standard Control Unit SCU

- For operating Pressmag SP and Pressmag HP
- Conform Euromap E 70 interface
- With SAFE functions (forced two-handed operation)



SCU
Control Unit

Touch Screen Control Unit MAGTCU 13

- Suitable for Pressmag SP and Pressmag LP
- Multiple levels of access for total operating staff security
- APAVE tested and approved.
- Accurate and reliable system monitoring thanks to state of the art 8" touch-screen display/controls to quickly measure:

- The magnetizing status on fixed and movable plates
- The magnetic flux on the fixed and movable plates.
- The clamping force measurement on each mold available as an option
- Status of the proximity sensor
- Status of the system alarm
- Status of temperature sensor

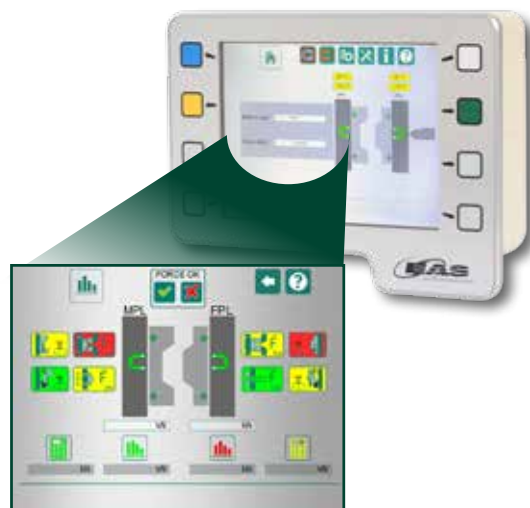

MAGTCU
13 Control

- Removable SD-card for offline system troubleshooting
- System automatically adapts to varying electric power conditions
- Automatic diagnostic function of control unit's internal components and sensors.



Ejector couplers

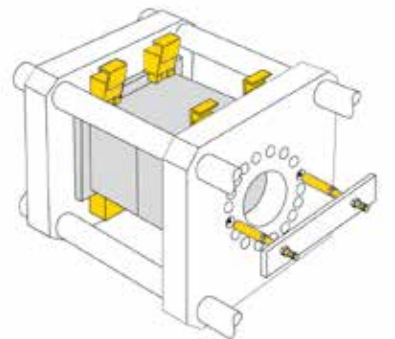
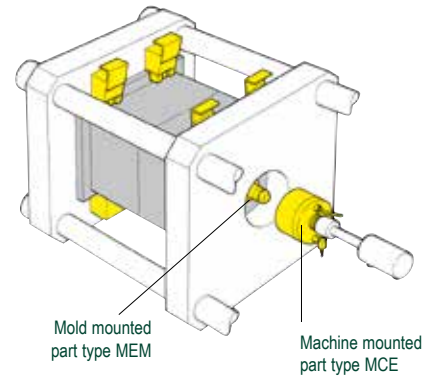
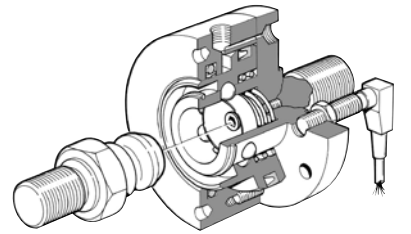
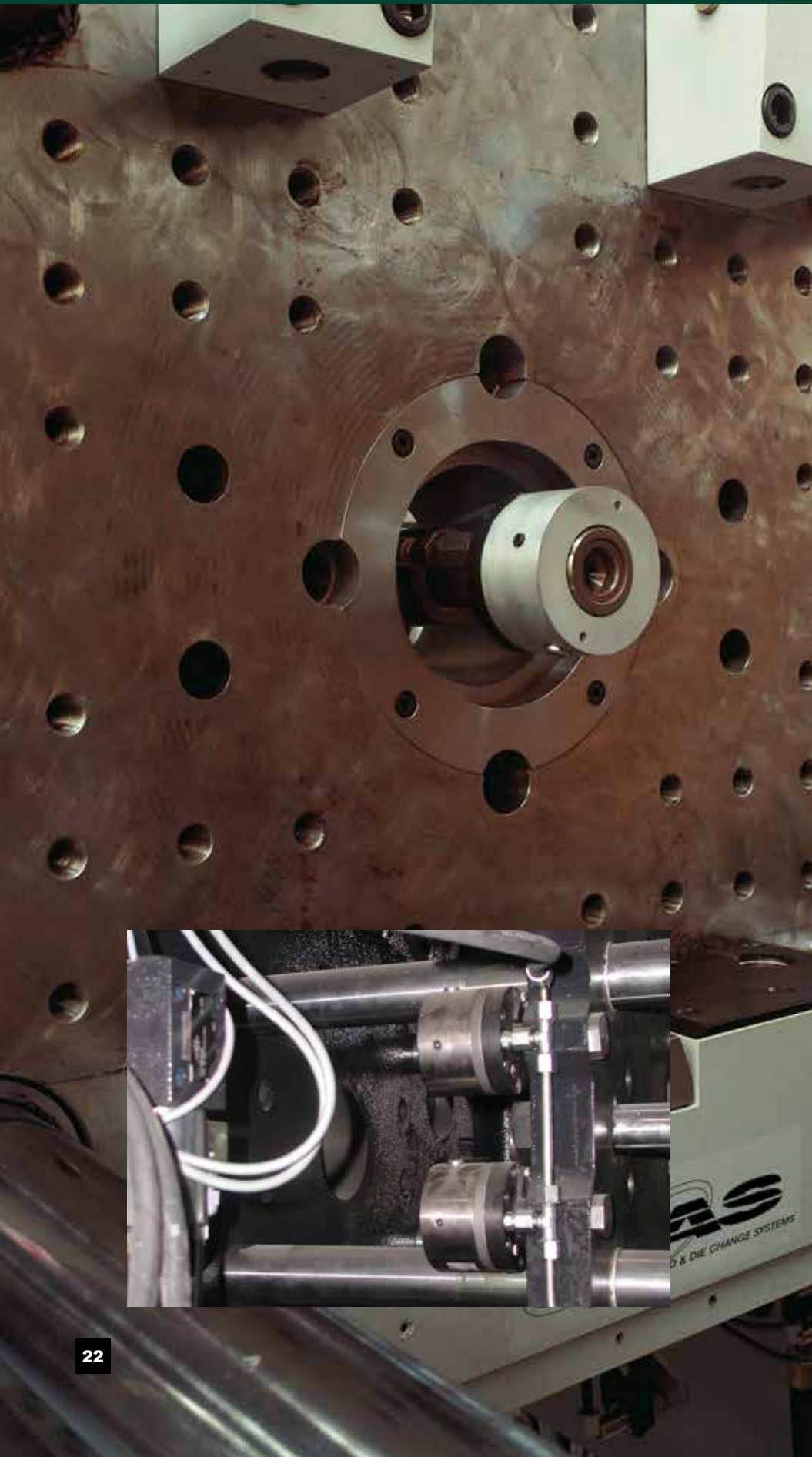

TIME SAVING AUTOMATIC EJECTOR COUPLER SYSTEMS

1.8

EUROMAP MACHINES

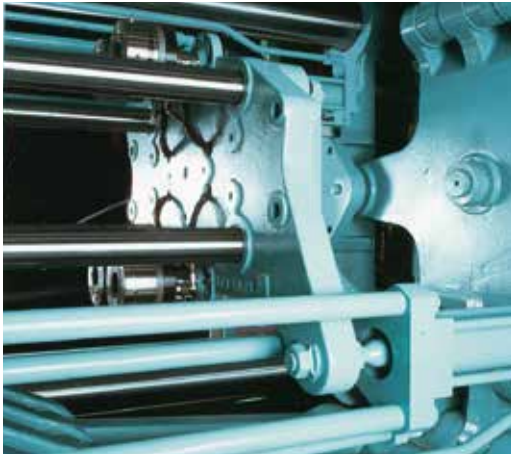

Ejector plate
and rods on
an injection
molding
machine



In addition to mold clamps, multi-couplers and change systems some molders require connection of the ejector system on the machine to the ejector system on the mold. The time consuming manual connections of the ejectors can be replaced by a simple automatic coupler system.

The EAS ejector couplers include a floating design to accommodate larger misalignment between the ejector coupler and the male adapter, which is mounted to the mold ejector rod.

Features:

Designed to VDMA 24465 part 5 standards. Hydraulically operated, single acting design. Life expectancy of 2×10^6 cycles at 50% of specified forces on the ejector coupler. Two proximity switches to indicate coupled and uncoupled position. Floating design allows 1mm of misalignment correction. The ejector couplers can also be operated pneumatically at reduced forces. Please consult EAS for pneumatic applications. Available in 20, 50, 100 & 200 kN capacities.

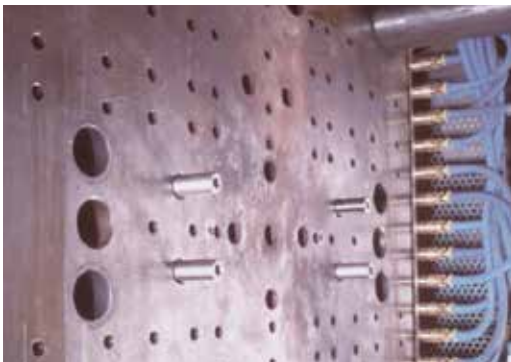

For machines with American SPI platen configuration EAS has designed SPI ejector couplers which can be used with the 1" and 2" SPI ejector patterns without platen modification.

Available in 1" or 2" diameter sizes the SPI ejector couplers simply push together, connecting the machine ejector to the mold ejector when the mold is loaded. When the mold is to be removed the ejector couplers are hydraulically pressurized to release. (WCE 10 can also be operated pneumatically)

Our WCE 52 ejector coupler features an optional proximity switch to provide a confirmation signal to the machine controls. Extension rods are available on request and are designed for the specific machine application. The oil inlet is located on the end of the adapter rod.

Features:

Sized for 1" and 2" knockout holes in the SPI platen configuration. Single acting design with hydraulic operation. Please consult EAS for pneumatic applications.

SPI MACHINES

Retrofit packages



EAS offers installation skills and manpower to install the QMC systems on your existing and or new machines .



FOR RETROFITTING EXISTING MACHINES

1.9



Retrofit solution with control unit and satellite boxes



Retrofitted machine

When the hydraulic clamps can not be powered by the machine tool hydraulic system, an independent pump and valve packages can be installed to provide the hydraulic power requirements. These pumps are often used on retrofit systems.

Another advantage is that when the machine is down, the mold change can still take place as the pump unit and controls are independent of the machine. For the MOD- and WOD-series of clamps, a mobile pump unit can be used for several machines as hydraulic pressure is not required when clamped but only at the time of the mold change. EAS have experienced installation crews to install these systems.

Control unit PCU-10

This central operating panel has a PLC control, a key switch and enables you to control all clamping, ejector and if needed multicoupler functions.

Satellite box SBL-14 and SBR-14

These boxes collect proximity switch signals from the hydraulic mold clamps. SBR-14 for 4 clamps, SBL-14 for 4 clamps plus the ejector coupler.

EUROPE

AMERICA

EASchangesystems offers retrofit QMC packages for existing injection molding, compression molding, thermal forming machines.

Retrofit packages include:

- Adaptive Clamp Options
- Manual Clamps
- Hydraulic Clamps
- Magnetic Clamps
- Manual Multi-couplers
- Automatic Multi-couplers
- Ejector Couplers
- Hydraulic Valve packages
(when hydraulic clamps are required)
- Hydraulic pump units
(when we can not use machine tool hydraulics)
- PLC System Control Packages
(when machine controls are not utilized)

EASchangesystems can also offer installation support.



Vertical presses and QMC

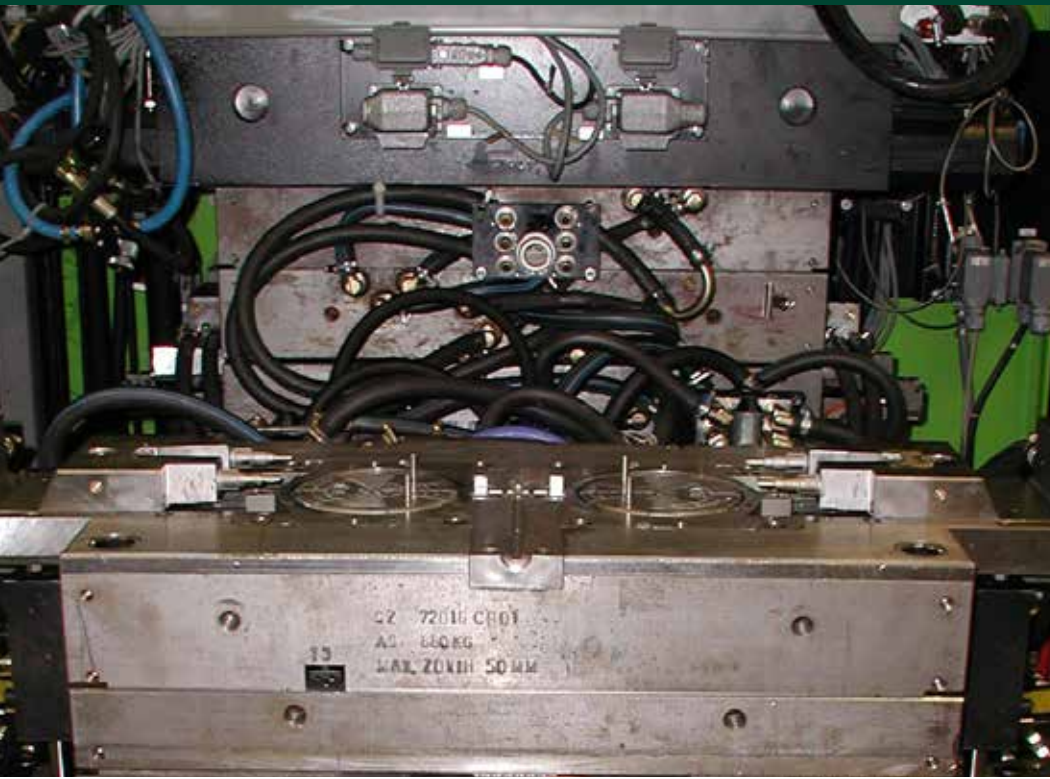

**ASK FOR THE COMPLETE
EAS QDC BROCHURE**

Mold carrier equipped with MOD type clamping cylinders and mold lifters. The mold is loaded by means of a manual mold change car.



MOD wedge clamps were integrated in a specially designed ring for this special "Ringwalz" machine to produce automotive wheel frames. Due to the self-locking feature of this clamp, hydraulic pressure is not required after clamping or during the rotational movement of the ring.



As well as changing molds quickly on horizontal injection and die cast machines, EAS can also change molds quickly on all your vertical injection presses, compression presses, rim presses, mold carriers and other special application presses. EAS offers complete range of products and solutions to solve these problems in quick and simple way.



Mechanical clamps mounted on a special plate with spring loaded mold lifters and an isolating plate as well as a set of pre-rollers make this mold change on this Duroplast press a simple job.

The pre-rollers are used for several presses by installing mounting hooks onto each press and moving the rollers from press to press.



Adaptive hydraulic clamps:

- Self-locking clamps type MOD
- Ledge Clamps type MLC
- T-slot Pull Clamps type MHC
- T-slot Clamps type MTC
- Travelling Die Clamps type TDC
- Permanent electric magnetic clamping systems



Integrated hydraulic clamps:

- Three Position Swing Clamps type MTR
- Swing Clamps type MSR
- Pull Cylinders type MPR
- The EAS Engel wedge clamps



Die lifters:

Spring loaded or hydraulic ball or roller die lifters for lifting and moving molds & dies over the lower bed of the press.



Pre-rollers:

Pre-rollers for simple loading and unloading of dies & molds in vertical presses.



Mold & Die change cars



2.1
Manual multi couplers
p. 30-31



2.2
Automatic multi couplers
p. 32-33

2

Manual and automatic multi couplers



Manual multi couplers

Simple and quick leak-proof connections of several water, air, oil and electrical circuits. EAS can provide you with a complete range of mono couplers as well.

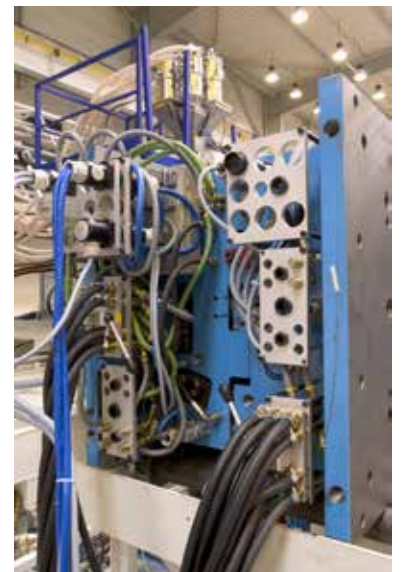
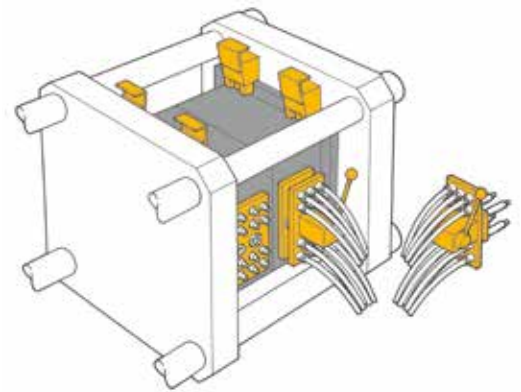

This is an example of how fluid connections are often done, resulting in inefficient cooling, leakage and high scrap rates.



Here is an example of the correct way of connecting several fluid circuits, without the risk of leakage or misconnection. When used in conjunction with a good water treatment system, EAS multi couplers will reduce scrap and improve the quality of your production.

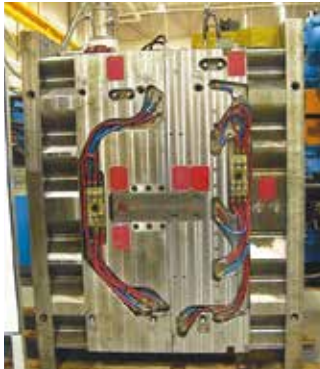

Two standard manual multi couplers with 12 water connections, a special manual multi coupler with 5 electric connectors for signals and heating purposes and one special manual multi coupler for hydraulic core pulling connections are mounted on these 40 t molds.

The fluid and electrical connections are done within 3 minutes and without leakage of water or oil, which keeps the area very clean.



A manual multi coupler with several electrical connectors for heating and sensor signals. A standard 12 connection multi coupler, with size 12 (1/2") water connections is used for the cooling circuits. A park station is used for hanging the manual multi coupler during mold change. These multi couplers solutions were implemented on five 1300 t machines.

The leak-proof EAS manual multi couplers are available in standard versions with 6 and 12 mono couplers. A variety of hose connection sizes and configurations are available for the mold half multi couplers.

These high quality leak-proof water couplers can also be combined with air, hydraulic and electrical connectors to provide quick connections for all of the molds utilities.

A simple parking station is provided to hang the machine side multi coupler during mold change, avoiding coupler damage.

With these coupler solutions, fluid and electrical connections can be made in a few minutes while keeping the floor and the system clean.

EAS can also supply a complete range of open and closed multi couplers which are completely interchangeable with a leading competitive brand. We can also supply a variety of interchangeable mono couplers some well known brands.

CONTACT EAS FOR MORE DETAILS.



Automatic multi couplers

EAS multi couplers include the following types automatic couplers;

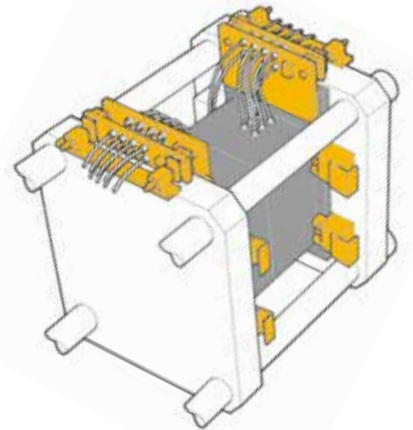

For vertical loading of molds
Designed for molds with many connections. With one or two moving docking cylinders to connect circuits independently of molds and machine movements.

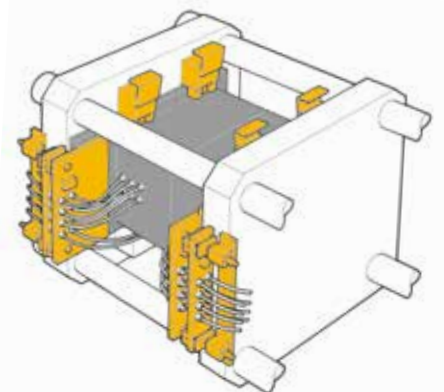

For horizontal loading of molds
Similar to vertical loading except the mounting of the multi couplers is at the side of the machine.

SIMPLE, LEAK PROOF AND FAST CONNECTION OF ALL YOUR FLUID AND ELECTRIC CONNECTIONS



This 2700 t injection molding machines with horizontal loading, has standardized multi couplers on the movable and fixed side of the machines. Connections for cooling water, hydraulics for core pull cylinders and electric for heating and signals, are automatically connected and disconnected. This connection takes less then 30 seconds. All couplers feature the leak proof couplers, keeping floor and envirement clean.



This multi coupler system for horizontal loading connects water and electric connections trouble free in less than 20 seconds. Another advantage of these multi couplers is that misconnections are being made any longer, which reduces the amount of bad products.

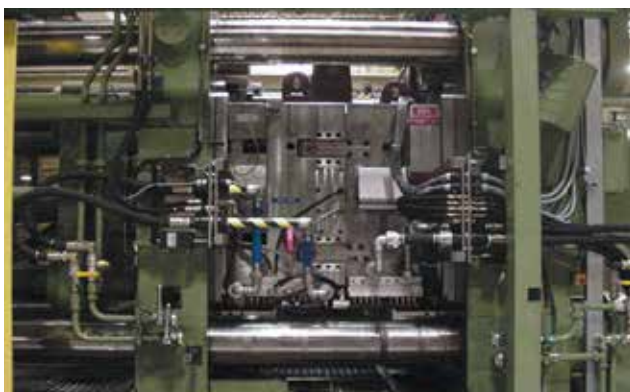

Large size 37 mono couplers are part of the multi couplers on this machine to connect leakproof large cooling lines. This in combination with heating oil connections and electric connections results in a total mold change time of less than 15 minutes in combination with hydraulic clamping and a vertical mold change by means of an overhead crane on this 2300 t machine. Fast, safe and clean.

Multi couplers can be used with different EAS couplers.

Most applications use our leakproof self locking couplers type CQF and CQM, where the two multi coupler halves are locked together by each individual mono coupler. These couplers are available from size 6 to size 45 up to 1500 l/min and for hydraulics up to 200 bar pressure. Special connect under pressure couplers are also available.

The advantage of self locking couplers:

Self locking couplers contain the separating forces which occur when pressurized. By containing these separating forces within the body of the coupler we are able to reduce the stress on the coupler plate and cylinders.

The other advantage with our CQF/M couplers is that if the mold is not in the machine, each coupler can still be connected for testing purposes.

Because of the leak proof design we can combine water, air, hydraulic as well and electric connections into one automatic multi coupler.

EAS also offers standard VDMA multi couplers. The number, position and arrangements of energy connections for automatic changing of injection molds are specified and standardized according to VDMA 24464 and Euromap.



3.1
Manual mold handling
systems
p. 36-37



3.7
Production cells
p. 48-49



3.2
Battery driven
Mold change cars
p. 38-39



3.8
Rail guided mold change cars
p. 50-51



3.3
Mold change tables
p. 40-41



3.9
Air floating mold change car
p. 52-53



3.4
Mold change tables for for the
automated manufacturing
p. 44-45



3.10
Customized solution
p. 54-55



3.5
Mold change tables for two molds
p. 44-45



3.11
Pre-heating station
p. 56-57



3.6
Mold change tables, positioned
between two presses
p. 46-47

3

Mold change tables and cars



Manual mold handling systems

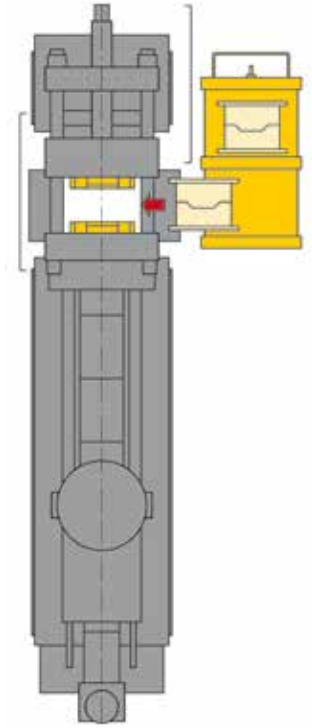

A SIMPLE HORIZONTAL WAY OF CHANGING MOLDS



Our manual mold change car for one mold of max. 800 kg.

Transferring the mold into the machine can be done manually or must be powered in depending on the weight of the mold. When the mold is light enough, manual transfer is practical. EAS offers the following solutions:

A manual car is used to transport the molds from the storage area directly into the machines. The adjustable height feature uses a hydraulic hand pump and cylinders to raise and lower the bed. The car can accommodate one 0,8 t or two 0,5 t molds. When the car arrives at the machine it is positioned to allow the existing mold to be manually pulled out of the machine. To support the mold between the cart and machine a set of bridge rollers are manually lowered. Once the mold has been removed the car is then positioned to allow the new mold to be manually pushed into the machine. The bridge rollers are then raised up out the way and mold is transported back to the storage area.

EAS can offer different solutions depending on mold size and space limitations. Cars can be configured for side load or end load operation depending on the plant layout. Both configurations speed the mold change process.



Mold change cars for vertical clean room press with air operated die lifters.



The molds are pushed and pulled manually.

Battery driven mold change cars

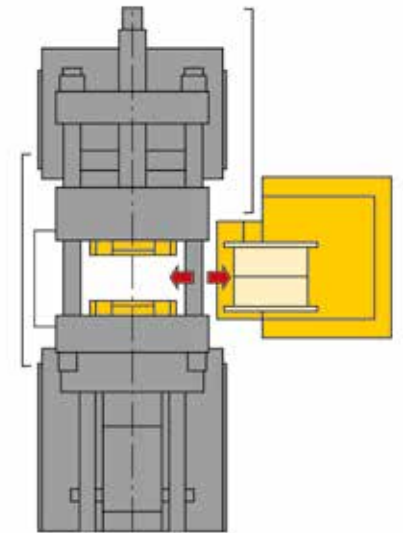

Mold change car with height adjustment 1 x 4 ton.

FLEXIBILITY, SPEED AND EASY TO HANDLE



1 x 20 t with a combination of electric drive and air cushion floating for exact positioning in front of the machine, storage and inspection unit.

When the molds are too heavy to be transported manually, a battery powered car with hand controls can be the solution. These cars can be equipped with variable height roller decks to accommodate different size machines and storage system levels.

Manual or powered push-pull mechanisms are available to transfer the molds in and out of the machine or storage system. These powered transfer mechanism can be operated electrically or with air.

Mold locks keep the mold from moving on the roller deck when the car is in motion. These cars handle one or two molds with a combined weight of 25 t and come equipped a battery charging system.

A two station mold change car can complete a mold change in less then 5 minutes when used with the press mounted roller and clamp system.

When docking the car to the machine is difficult due to space limitations, EAS can supply a combination battery powered drive and air cushion car. For normal transport the battery drive is used. Once at the machine where space and maneuverability are a problem, the air cushion system is connected to the air supply and the car is easily floated into the exact position for loading.



Electric driven 2 x 2 ton mold change car serving several machines and storage systems.



1 x 7 t with height adjustment but with powered transfer of the molds over the rollers.

Mold change tables

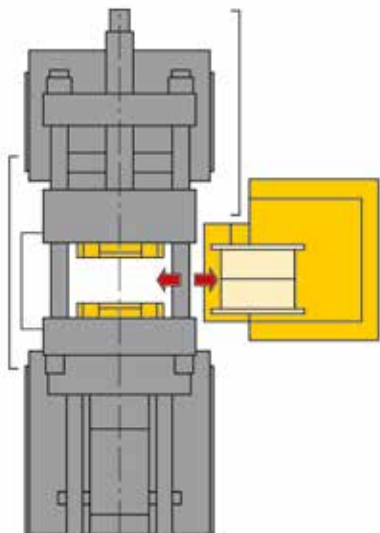

FOR SMALL AND LARGE MOLDS UP TO 200 TON WEIGHT



On an Italttech 1000 t injection molding machine EAS delivered the horizontal hydraulic adaptive clamping systems and a mold change table for molds of maximum weight of 40 t. Guides on the table allow the crane driver to easily position the large mold in a simple way on the table. An air driven push-pull spindle device moves the mold in and out the machine. All water, hydraulic and electric connections are made with manual multi coupler systems.

Single station mold change tables dedicated to an injection molding machine. They are used when horizontal loading is required and molds are changed infrequently or space is not available for two station mold change tables (see the next pages for multi station tables).

These tables can use a manual or powered transfer mechanism depending on mold weight to load and unload the machine. The powered transfer can be equipped with an automatic push button control.

When using a single station change table you must first pull the mold from the machine and remove it from the table by overhead crane or fork lift truck. The new mold is then positioned on the table roller deck. The new mold is then pushed into the machine. These tables are used in conjunction with clamp and roller systems in the press (see page 12 & 13).

The time required to do a complete mold change is depending on the size and weight of the mold. For example, a 40 t mold could be changed in less than 15 minutes.



A 1000 t injection molding machine is equipped with an adaptive horizontal hydraulic clamping system, an ejector coupler, automatic multi couplers and a mold change table for one mold of maximum weight of 15 t.



A table for 1 x 15 t mold with on one side the rollers with mold guidings, while on the other rollers molds with different dimensions can be placed. This table has a fixed operation panel. This table also features two guides to enable the crane operator to position the mold easily.



Mold change table for the automated manufacturing



FULLY AUTOMATIC MOLD CHANGE SOLUTIONS



Single station mold change tables at each side of the injection molding machine with driven rollers on the table and in the machine provide very fast and automated mold changes.

Mold change over time of less than 50 seconds can be achieved for 15 ton molds for example. This can be achieved by synchro movement of the new mold moving in while the old mold moves out on the other side of the machine.

EASchangesystems deliver the complete solutions from one single international source for these full automatic production cells. Inside the machine we supply hydraulic or magnetic clamping systems, powered rollers and centering cylinders as well as automatic multi couplers and ejector couplers. Outside the machine EASchangesystems supply the mold change tables with powered rollers and pre heating multi couplers.

The molds are equipped with the mold size multi couplers and with automatic mold half locking devices.

And if required we do the piping and or hose connections as well. Meaning you have ONE SUPPLIER coordinating the solution with also the machine supplier(s), the mold maker, the cooling and robot supplier if required.



Inside the machine driven rollers on the fixed side.



On both side of the machine a mold change table with pre heating and cooling down multi couplers.

Mold change tables for two molds



Step 1

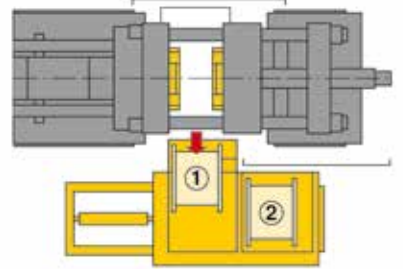

Step 2

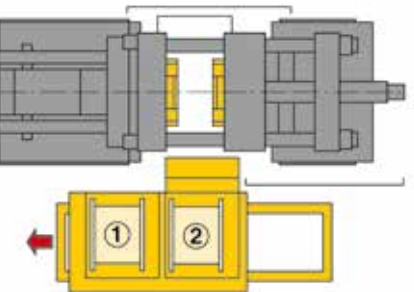

Step 3

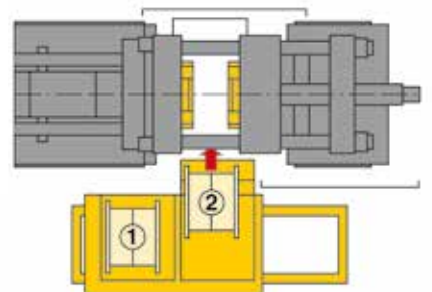

MOLD CHANGES WITHIN MINUTES INSTEAD OF HOURS



Mold change table for two molds of max 2 x 60 t. This table features a pre-heating station with automatic multi couplers connections.

Mold changes with a two station mold change table are faster than a single station mold change table because the mold is pre-staged on the table. Additional time can be saved by pre-heating the mold on the table.

When changing a mold the mold in the machine is pulled on the empty station on the table. The table is then shuttled to position the new for loading. The new mold is then pushed into the machine. EAS provides powered transfer mechanisms which load from one side of the table or both sides of the table. Powered roller transfer is also available. This system utilizes powered rollers on the table and in the press to provide the fastest method of changing molds.

When mold change tables are used with 2 presses they increase your flexibility to run smaller production batches and reduce inventory. Side load systems increase safety for the operators because the mold is always supported and guided during the change. Mold change tables are equipped with Programmable Logic Control (PLC) system which allows manual, semi-automatic or fully automatic operation. Automatic operation requires interfacing with the machine controls, and they are most often applied on new machines.

Mold change tables are often equipped with a hydraulic power unit to power table movements as well as clamping, ejector couplers and multi couplers.

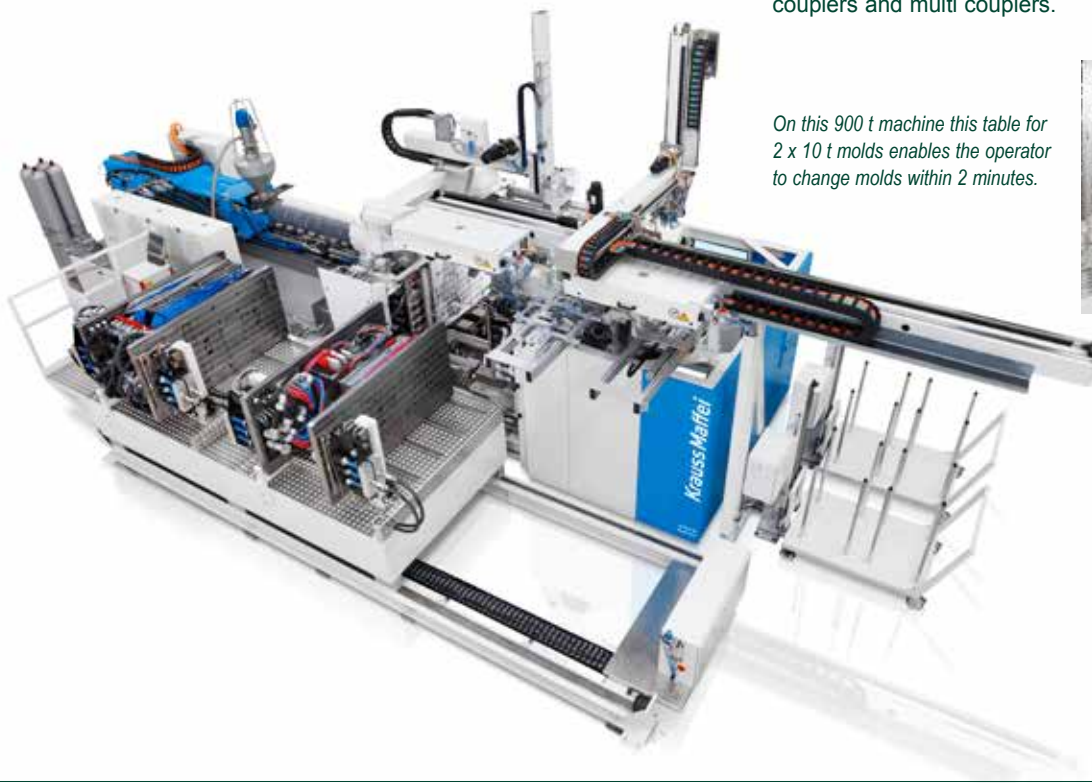

On this 900 t machine this table for 2 x 10 t molds enables the operator to change molds within 2 minutes.





Mold change tables, positioned between two presses

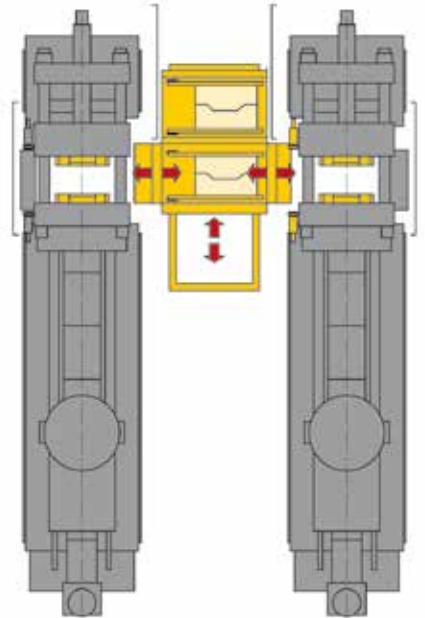

The modular design for mold change tables from EASchangsystems.

MOLD CHANGE TABLES INCREASE YOUR FLEXIBILITY, SPEED AND SAFETY

3.6



When using a mold change table between two injection machines you will improve your return on investment because the table is supporting two machines instead of one. This provides greater flexibility and faster changeover.

EAS has implemented solutions with overhead push/pull devices, telescopic push/pull devices to load from both sides of the table as well as powered rollers. Powered rollers provide the fastest changeover because you do not have to wait for the push/pull device to travel into the machine.

At this application a mold change table was placed in between two 2700 t injection molding machines and is able to carry two 40 ton molds. The molds are loaded and unloaded on the table by an overhead crane. The table is equipped with pre-heating multi couplers, allowing the new mold to be heated prior to its movement into the machine, saving hours of unproductive time.

At this application EAS selected an overhead transfer mechanism, which is mounted over the table and on the two machines. Each mold is equipped with two connection bars, mounted on top of the fixed side of the mold. With this solution a mold change can be done within 10 minutes.

Note: *If no overhead crane is available to load and unload the molds on the table, the table can be equipped as a rail guided car. This table-car brings the molds then to storage positions where several molds can be stored.*



EAS changes systems tables and cars are built up from a modular design. Moldweight range from 5 t till 100 t. EAS installation at the customer.



Production cells

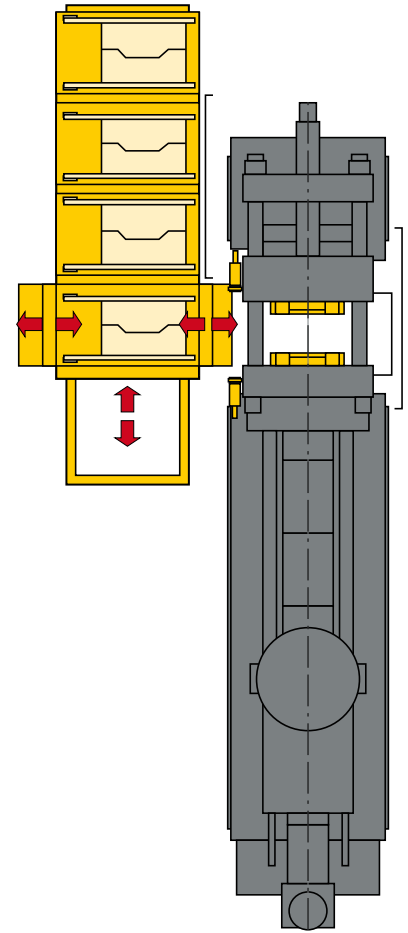

FOR YOUR COMPLETE AUTOMATED PRODUCTION



A fully automatic production cell with pre-heating station working with a 250 t injection molding machine.



A 150 t machine with a 2 way 3 position mold change table, pre-heating, multi couplers, hydraulic adaptive clamping and an ejector coupler. The pre-heating equipment is stored under the table and can be easily reached.

Completely automated production cells can run very small batches before changing over for the next run. These 2, 3 or 4 station change tables include pre-heating features and change molds automatically.

The molds can be loaded onto the table by overhead crane or fork lift truck by opening the safety gate.

The EAS production cells consist of clamping systems, ejector couplers and multi couplers on the machine and the multiple station mold change table with pre-heating system, all operated by PLC controls and on board hydraulic system.

EAS can also provide standardized mold back plates, mold side ejector coupler adapters and multi couplers.

In most applications we work closely with the machine manufacturer to interface cell controls with the machine controls.

Time is money



Rail guided mold change cars

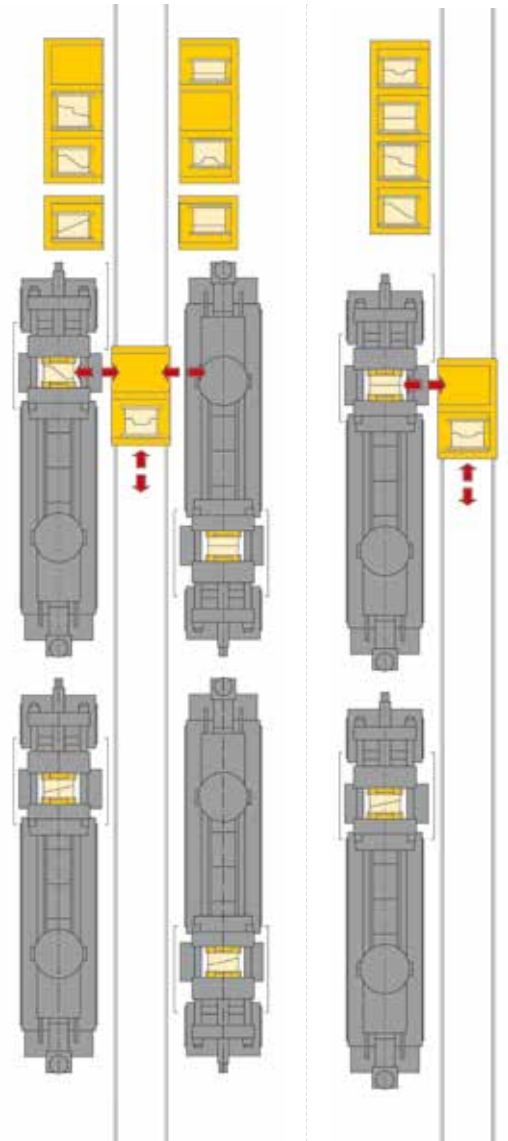

Mold change car travels within rows of machines and storage systems and pre-heating stations, changing to both sides of the car.

Mold change car to pick up molds from the storage and to bring to one or more machines.

QUICK, SAFE AND SIMPLE FOR MOLDS UP TO 200 TON



2 x 20 t car with height adjustment



2 x 40 t car in between 7 machines



A further step towards automation is the installation of a rail car system to serve one or more injection molding machines in a complete line of machines.

This usually means a complete reorganization of the plant and is most often done at new plants. The mold change car transports the molds to and from the storage and or pre-heating stations. Unlike the mold change tables, the cars are not equipped to activate the requisite clamping and energy coupling operations. The cars can be battery powered or by an overhead power rail or by a cable trolley; in most cases the option is determined by the rail length and the normal frequency of mold changeovers.

The cars are equipped with positioning devices for exact positioning along the machine or at the storage rack. They can be equipped by a manual or an automatic connection for the machine interface. The mold change device can load one side of the car or to both sides of the car in case the car travels in between rows of machines. Economy versions are equipped with spindle push/pull devices. More advanced cars are equipped with telescopic push/pull devices with automatic mold grippers or with driven rollers.

For safety purposes, each mold roller bed is equipped with a mold lock, which holds the mold on the car during transport along the machines. Safety bumpers, acoustic or light signals can be part of the car. The cars can be operated manually, semi automatic or completely automatic. The operator can either walk along with the cars or drive on the car from an operator platform. For different sizes of machines the car can be equipped with height adjustment. Loading and unloading of the molds can be done from the storage systems or by an overhead crane. The storage systems can also be loaded by an overhead crane or by a fork lift truck.

Mold change times for 40 t molds can be accomplished in 10 minutes with these solutions.



Air floating mold change cars

Air floating cars actually float on air film like a hovercraft and are therefore very flexible in moving around pillars or in restricted areas and can carry very heavy loads.



A 110 t mold is transported from its storage system to the injection molding machine or inspection unit. This customer, a producer of large plastic container, had no overhead crane available for such heavy weights and this solution enables them to change these molds within 35 minutes. The push pull mechanism is a simple spindle device, which pushes or pulls the molds in or out the large twin machine.



Space is very limited around the machines at this automotive supplier, two air floating cars for 1 x 20 t molds are used to change molds in less than 15 minutes.



For extreme heavy molds as at this container manufacturer EAS installed this air floating system in combination with storage systems, a 3400 t and a 6000 t injection molding machine as well as an EAS inspection unit. The car can handle up to 150 t molds and the change over time is less than 30 minutes.

Air floating cars actually float on a thin film of air like a hovercraft which provides great mobility in restricted areas. They can also carry very heavy loads without special floor reinforcement.

An air floating car can be an interesting alternative to rail guided mold change cars. They easily move very heavy loads (up to 200 tons or more) in tight spaces while providing greater flexibility in plant layout than a rail system. The floor must have the cracks filled, be sealed, and level for the best performance. A suitable air compressor is required with an appropriately sized air hose. For greater range without several connections points, an air compressor can be placed on board the car. Noise level is surprisingly low.

The upper roller deck is the same as a rail guided cart and features the same style of transfer devices, guides and mold locks. They can be loaded from a mold storage rack or by overhead crane.

Air floating cars can be easily positioned in front of the machines with docking rails and locked to the machine. They can be controlled by a pendant control panel or by radio control.

Air powered drive wheels control the speed and direction of the cart while the cart is moving.



Air floating solutions can be very attractive for smaller mold handling requirements. It can also be combined with an electric drive system to travel longer distance. The operator can walk behind or even sit on board. Contact EAS for very creative solutions to your mold handling problems.

Customized solutions



Tug unit to transport 20 t molds.





For a range of vertical mold carriers, producing different internal part for a well-known car manufacturer in Germany, the space in front of the mold carrier was very limited. A special designed electric driven car on rails was developed to overcome these difficulties.

The car can carry two molds of each 20 t and the upper bed can turn 180 degrees. The mold sequence is therefore as follows: the car arrives with the new mold on the car, it docks on at the press. The existing mold is pulled from the machine onto the car, then unlocks and drives back two meters where the upper bed is turned 180 degrees. The new mold is now brought to and into the machine with a total mold change time of 10 minutes.



A well-known Italian car manufacturer developed a very special injection molding machine to produce car bumpers. The requirements were: faster, more flexible, reduce labor cost, reduce energy consumption, reduce floor space and optimize the production process control by automation.

The mold change cars are having the following features;

- Two way two direction travel with one guiding rail
- A 65 t load bearing capacity
- A floating upper bed table permitting easy self centering of the mold with the upper platen
- Compact size
- Control by means of a remote push button station
- A floor installed carriage guiders, mono rails and side tracks with crossing for two way movement
- Change over time for 1 mold in less then 10 minutes

Special presses or other unusual circumstances lead sometimes to inventive solutions by EAS as the picture on page 54 shows.

Because no overhead crane is available at every machine EAS designed this electric driven car to lift and lower molds up to 2 t over and in the injection molding machine. The vertical lifting stroke is 3000 mm and the horizontal stroke is 1500 mm.

Ask EASchangesystems for your applications.



EASchangesystems offers a wide range of transportcars.

Pre-heating stations



SAVE HOURS ON YOUR EXPENSIVE PRODUCTION MACHINES



This separate mold pre-heating station is used to preheat 20 to 40 t molds outside the press.

In addition to the use of time saving automatic clamping and multi coupler systems, pre-heating molds outside the machine can drastically reduce mold change over down time. Once clamped in position, with the energy circuits connected, a preheated mold is ready for instant production.

This pre-heating can be done by a separate pre-heating station or by integrated pre-heating on the mold change car or table. Dependant on the degree of automation involved, such a station can be equipped with manual or automatic multi couplers and the requisite temperature controllers.



Integrated pre-heating station on a mold change table with automatic multi couplers equipped with leak proof hot oil couplers and electric connections.



4.1
Inspection units
p. 60-61



4.2
Mold turning units
p. 62-63



4.3
Storage rack systems
for molds & dies
p. 64-65

4

Service units and storage systems



Inspection units



For molds up to 3 t EAS offers the Optim 25 service units



The standard units are all 1200 mm long, 580 mm wide and 275 mm high. The two turning platforms are 350 x 500 mm. Optionally the units can be placed on a higher table for easier access or if you have other requirements such as clamping solutions.

You can discuss these with your EASchangesystems partner.

SIMPLE AND SAFE MAINTENANCE OF YOUR EXPENSIVE TOOLS



A German supplier of washing machines uses this inspection unit with two tilting platens for 20 t molds. The loading and unloading of the molds is done by an electric driven and air floating mold change car. The unit can also simulate core pulling movements and ejector couplers movements.



For a well known German manufacturer of plastic containers EAS equipped several large injection molding machines up to 6000 t with an adaptive hydraulic clamping systems, an air cushion mold change car, several mold storage racks and an inspection unit for molds up to 100 t.



A small unit for molds of 2 t and with tilting platen. The control panel can be move around the unit by the operator. Safety mirrors as well as safety mat are also installed on this unit.

A further stage in the automation of your injection molding plant is the installation of an inspection unit. This rationalizes the inspection and servicing of molds, superceding a variety of slow and sometimes hazardous methods involving jacks and levers or block-and-tackle. Equipped with hydraulic or magnetic clamping systems on fixed and movable plates, the inspection unit greatly facilitates the rotation and precise positioning of molds for maintenance and repair work; either as separate halves or coupled tools.

EAS supplies these units in several sizes up to 200 t mold weight. The units can be equipped with hydraulic cylinders to tilt one or two mounting plates 90 degrees.

For safety reasons the units can be equipped with a safety mat, which stops all movements if somebody steps into the table and or with safety light curtains which also stops any movement if somebody comes too close to the unit.

The unit can be equipped with a number of options;

- Additional hydraulic or magnetic clamping systems for automatic vertical or horizontal mold loading.
- U-shape backplates in order to be freely accessible from the back.
- Multi coupler systems, manually or automatically for preheating purposes and or for controlling and checking the core pull cylinders.
- Movable upper clamping systems for different sizes of backplates.
- Ejector coupler with ejector cylinder for simulation of ejector movements.
- Steps and stairs for better excess.
- Connection for machine control to simulate certain programs.
- Spotting capability up to 20 t.

For large container production heavy molds up to 110 t are being transported by an air-floating car from the storage into this inspection unit.

Either the mold half or the total mold can be turned on one side of the unit. The back of the plate is open, allowing maintenance and inspection at the back of the mold. Hydraulic core pulling cylinders are actuated in sequence with the opening stroke. Easy and safe maintenance without a huge overhead crane enables this customer to deal with transport and maintenance of very large molds.



Mold turning units



COMBINATION OF A MOLD CHANGE CAR AND AN INSPECTION UNIT



A special electrically driven mold change car for molds up to 1700 kg is also used as an inspection unit.

The car has also height adjustment from 950 mm towards 1300 mm and has an electric push/pull device to change molds on vertical press. The platen on the car is also equipped with spring loaded mold lifters from the EAS QDC program. Away from the press the mold halves can be separated over a distance of 600 mm and each platen can be turned 90 degrees for maintenance.



*Mold change-inspection car.
Electric driven and hand controlled.
Max. mold weight 1700 kg.
Mold push and pull device on both sides.
Spring lifting die lifters in the platen.*

EAS mold rotator type EMS

Despite their high value, the turning and opening of expensive molds and dies is still often done by means of an overhead crane. This is a dangerous work for the operator and the risk of damaging the expensive tools is high. Using EAS mold rotators one operator can easily and safely rotate the mold. Standard models are available from 3 ton mold weight up to 50 ton.



EAS can also supply mold turning or mold manipulators to turn your expensive molds 90 degrees for transport or storage in a different way.



This turning unit is for molds up to 20 t and is remote controlled. EAS can supply these units up to 100 t mold weight.

Storage racks for molds and dies

EASchangesystems offers a wide range of mold and die storage systems. These are simple roller beds for horizontal mold storage. They can be manually operated or fully automated.

Most of the time they are used in combination with a free movable mold change car or a mold change car on rails or an air floating car. This means there is no need for an overhead crane anymore for loading and unloading the mold.



TOOLS NEED TO BE STORED AND IN MANY CASES THIS IS AWAY FROM THE MACHINES



Mold storage racks in combination with a mold change car on rails. One of the storage racks is equipped with multi couplers and is serving as a pre heating station.

If rail guide mold change cars, air float mold change cars, electric driven or manual free moving are being used one car easily load and unload the molds from these handling systems onto horizontal mold storage systems or pre heating systems. These horizontal storage systems are equipped with rollers, a mold stop and a mold locking device and can be placed near the machine or in other parts of the plant. In case of a railguided system the storage racks can be placed on both sides of the rails.



These horizontal mold storage systems are loaded and unloaded by means of electric driven mold change cars, on which either manual or automatically molds are placed. Underneath the molds is room for other mold related equipment.



This electric driven mold change car for a large vertical press can bring the molds far away from the press to a special mold storage area. The molds can be stored left and right of the electric driven car. The driver has a camera and a monitor for exact positioning the car into the press. Changing and store molds between 10 and 20 t is in this way simple, fast and safe.

Rotomolding Pressmag SPRO

Closing and opening rotomolding molds quickly and safely is done efficiently with magnetic electro-permanent clamping solutions from EASchangesystems. Our Pressmag SPRO system requires electrical power only for a fraction of a second to activate the magnetizing and de-magnetizing process – greatly minimizing energy consumption and heat build-up.

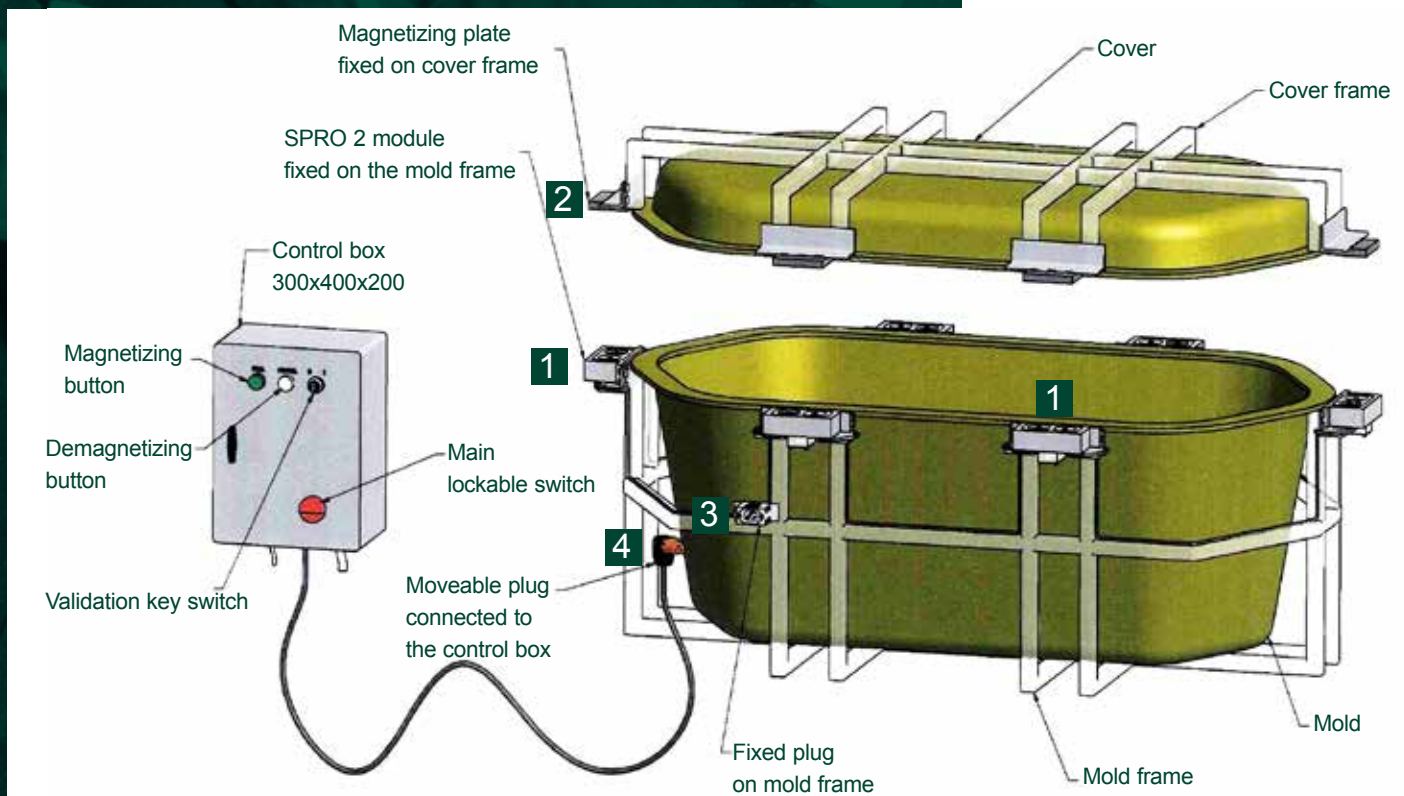

WHAT ARE THE BENEFITS OF MAGNETIC ELECTRO-PERMANENT CLAMPING SOLUTIONS FROM EASCHANGESYSTEMS?

- Replaces time consuming screw and/or toggle method of closing and opening the molds.
- Eliminates need for noisy air tools and/or torque wrenches.
- Increases operator safety: no need to handle high temperature system components.
- Does not require additional staff for clamping/unclamping operation.
- Saves time and money as it reduces the production process.
- Can be used in high temperature applications up to 300 °C during 20 minutes.
- Compatible with aluminium molds.
- Compact and modular clamping solution.
- Available with 1, 2 or 4 poles, depending on the required clamping force and available space.
- Control unit with cable, socket and connector included.
- Only one Control Unit required for several molds; can handle up to 40 SPRO pole modules.
- Simple to use.
- Quick and easy installation.

- 1 Pressmag SPRO unit fixed on the mold frame or on the mold with 0,6 or 0,9 meter isolated cable.
- 2 Counter plate fixed on the cover plate or on the cover itself.
- 3 Fixed connector attached to the frame or to the mold.
- 4 Movable connector to the control box with 3 meter connection cable:
 - Fully assembled and ready to use (size 300 x 400 x 200 mm)
 - Requires both hands to activate magnetizing and de-magnetizing functions
 - 400V AC

ROTMOLDING MADE EFFICIENT WITH MAGNETIC ELECTRO-PERMANENT CLAMPING SOLUTIONS FROM EASCHANGESYSTEMES

COUNTER PLATE/ROTMOLD COVER

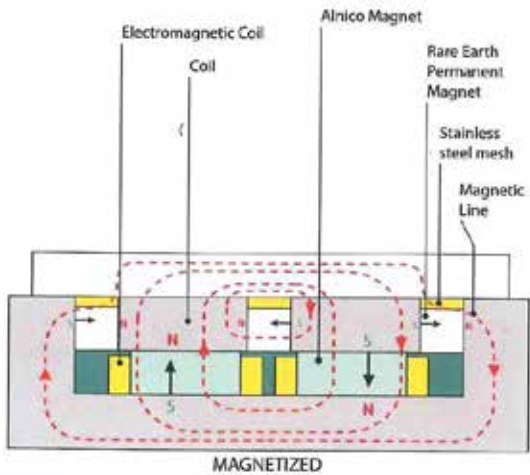
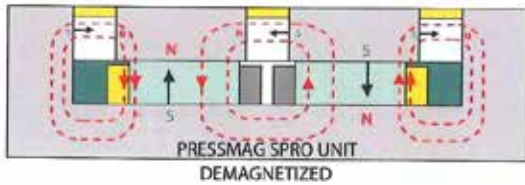

PRESSMAG SPRO

Permanent electro-magnetic Pressmag SPRO systems have a 47 mm square base and feature two magnets which are surrounded by an isolated coil. The square poles are fitted with non-invertible, permanent, rare-earth magnets and are round on the clamping surface. A laser-cut stainless steel mesh seals and covers the complete system.

The coils surrounding the invertible magnets generate an electromagnetic field which inverts the magnets within a fraction of a second. The molds are thus clamped for an unlimited amount of time, without the need for more electric energy, or heat generation. During the time that the mold is in the machine, rotates, heated and cooled down, there is no need for the electric connection.

The control unit is only connected in case of closing and opening of the mold. A new electric pulse will de-magnetize the system, releasing the mold cover and clearing the clamping surface of any magnetic flux. After a magnetizing sequence, each square pole becomes either a North or a South Pole - and is again neutralized after having been de-magnetized.

Europe/The Netherlands

EAS Europe B.V.

De Hooge Hoek 19A / 3927 GG Renswoude
phone: +31 318 477 010 / The Netherlands
info@EASchangesystems.com

USA

EAS Mold & Die Change System, Inc.

N50 W13740 Overview Dr Suite F / Menomonee Falls, WI 53051
PO Box 1614 / Milwaukee WI 53201
phone: +1 262 783 7955 / United States of America
easus@EASchangesystems.com

France

EAS France S.A.R.L.

604, Voie Galilée / ZI Alpespace
73800 Sainte Hélène-du-Lac
phone: +33 4 79 65 04 10 / France
easfr@EASchangesystems.com

China

Suzhou EAS Mold & Die Change Systems Co. Ltd.

No.1188 Pangjin Road / Wujiang City / 215200
phone: +86 51 26 30 91 / PR China
sales-china@EASchangesystems.com

Italy

EAS MED S.r.L.

Via J. F. Kennedy, 19/C2 / 20871 Vimercate (MB)
phone: +39 039 608 3816 / Italy
easmed@EASchangesystems.com